

# Influence of shock wave propagating in case on the detonation characteristics

Fumihiko Sumiya\*†, Hideki Hamashima\*\*, Yukio Kato\*, and Shigeru Itoh\*\*

\*NOF Corporation, Taketoyo Plant, R&D Department, 61-1 Kita-komatsudani, Taketoyo-cho, Chita-gun, Aichi 470-2398, JAPAN

†corresponding author: fumihiko\_sumiya@nof.co.jp

\*\*Shock Wave and Condensed Matter Research Center, Kumamoto University, 2-39-1 Kurokami, Kumamoto 860-8555, JAPAN

Received: May 27, 2005 Accepted: August 2, 2005

## Abstract

The detonation characteristics of non-ideal explosives, especially the emulsion explosives, are critically affected by the confinement of case. In this study, we focused the shock wave propagating in case as confinement effect factor. Therefore, the objective of this study was to obtain a better understanding of the influence of shock wave propagating in case on the detonation characteristics of explosives.

The propagation of shock wave in case material and in material filled into case was investigated. Polymethylmethacrylate (PMMA), copper and aluminum were chosen as a case material. Water and the emulsion explosives were used as sample material confined in case. Good relationship between the acoustic impedance density, which is derived from the product of density and sound velocity, and detonation velocity was observed.

In addition, the detonation characteristics of emulsion explosives precompressed by shock waves induced by precursor shock wave propagating in PMMA case were investigated by another experiments. It was confirmed that the detonation characteristics of emulsion explosive was affected by the precursor shock wave propagating in PMMA case.

**Keywords:** Shock wave, Emulsion explosive, Case material, Propagation speed, Visualization

## 1. Introduction

It is well known that industrial explosives as typified by ANFO explosive and emulsion explosive behave the non-ideal detonation. One of the useful methods for convenient evaluation of non-ideality is to measure the detonation velocity and to compare its value to the theoretical predicted value. The ratio between the measured value and the theoretical predicted value is often converted to the reaction ratio of its explosive. However, the value of detonation velocity measured on the non-ideal explosives does not easily reach the theoretical predicted value. Because many factors affect the detonation velocity of a given explosive, including explosive type, diameter of the explosive charge, confinement, density, temperature, ingredients, initiation method, booster type and size, pre-compression by previous detonation wave and so on.

In general the non-ideal detonation behavior is conceptually explained by its long reaction zone and the energy loss

by rarefaction wave. The reaction zone length increases with increasing its density of non-ideal explosive. With increasing reaction zone length the detonation velocity decreases, because the pressure and temperature in the reaction zone are more strongly affected by the side rarefaction waves intruding. Making additional mention of energy loss, generally the detonation velocity decreases as the diameter of the explosive charge decrease. This phenomenon is caused by the detonation pressure fall at the side of the explosive charge. When the diameter is large the energy loss is small relative to the generating energy at the detonation front. To the contrary, when the diameter is small the loss is larger relative to the generating energy at the front. The large or small energy greatly affects the reaction speed of explosive, i.e., detonation velocity. This behavior is called "diameter effects". From this point of view, the diameter of the explosive charge must be the one of the important factors that influence on detonation veloc-

ity. Regarding diameter effects, many research papers have been reported for emulsion explosives<sup>1-4)</sup> and for ANFO explosives<sup>5)</sup>.

A. C. van der Steen *et al.*<sup>5)</sup> also had investigated the effect of confinement on the detonation velocity for ANFO explosive. Several sizes of steel tube were chosen for the confinement of case. Inner diameter of steel tube was constant, but its wall thickness was varied to change the strength of the confinement of case. They concluded that the tube diameter had a much greater effect on the detonation velocity than the confinement. Arai *et al.*<sup>6)</sup> had investigated the confinement effect on the detonation velocity for ANFO explosive using the resin tubes made by the several kinds of material respectively. They summarized the relationship between the physical and mechanical properties of tube materials and the detonation velocity measured in resin tubes. The physical and mechanical properties mean the dynamic Young's modulus, the dynamic shear modulus, the dynamic bulk modulus and the dynamic Poisson's ratio. It was found that the detonation velocity increased with an increase in Young's modulus, shear modulus, and bulk modulus, and there was a tendency that the Poisson's ratio increased with the decrease in the detonation velocity.

S. Esen<sup>7)</sup> had carried out the statistical approach to predict the effect of confinement on the detonation velocity of industrial explosive including emulsion and ANFO explosives. A great number of measurements for the detonation velocity were conducted at the actual mines, the empirical model for the effect of confinement on detonation velocity had been developed based on those measurements. The dynamic rock properties, those are, the dynamic Young's modulus and the dynamic Poisson's ratio are adopted as a parameter into the modeling equation. These rock properties were calculated as the function of the density, P-wave velocity and S-wave velocity of intact rock. It is shown that the detonation velocities of industrial explosives depend on explosive and rock type and borehole diameter.

P. C. Souers *et al.*<sup>8)</sup> had conducted to compare the confinement effects both at constant radius and at constant detonation velocity. Pressure contours in explosive and in confinement were calculated using the hydrocode model with the parameters of  $U_s$ : detonation velocity and  $C_0$ : zero-pressure sound speed in steel. However, it is concluded that the effect of confinement on detonation velocity is shown to be complex.

In this study, we focused the shock wave propagating in case as a confinement effect factor. Therefore, the objective of this study was to obtain a better understanding of the influence of shock wave propagating in case on the detonation characteristics of explosives through two approaches by photographic observation. At the one approach the propagation of shock wave in case material and in material filled into case was investigated. And at another approach the detonation characteristics of emulsion explosives pre-compressed by shock waves induced by precursor shock wave propagating in PMMA case were investigated.

## 2. Experimental

### 2.1 Emulsion explosives

Three types of emulsion explosives with the same emulsion matrix and the different kind of microballoons were prepared in this study. The emulsion matrix used has a density of  $1400 \text{ kg m}^{-3}$  with the formulation of ammonium nitrate and sodium nitrate / hydrazine nitrate / water / wax and emulsifier = 78.7 / 5.5 / 11.0 / 4.8. A certain amount of inorganic or organic microballoons was added to the emulsion matrix respectively to adjust the initial explosive density of  $900 \text{ kg m}^{-3}$ .

Sample emulsion explosive named EMX 1 was sensitized by polystyrene resin microballoons with multi-cell structure (average diameter; 2.2 mm, true density;  $43 \text{ kg m}^{-3}$ ). Detonation velocity of sample EMX 1 was  $2370 \text{ m s}^{-1}$  at  $\Phi 30 \text{ mm}$  unconfined in air. Sample emulsion explosive named EMX 2 was sensitized by glass microballoons with mono-cell structure (average diameter; 0.06 mm, true density;  $250 \text{ kg m}^{-3}$ ). Detonation velocity of sample EMX 2 was  $4140 \text{ m s}^{-1}$  at  $\Phi 30 \text{ mm}$  unconfined in air. Sample emulsion explosive named EMX 3 was sensitized by acrylonitrile resin microballoons with mono-cell structure (average diameter; 0.05 mm, true density;  $27 \text{ kg m}^{-3}$ ). Detonation velocity of sample EMX 3 was  $4640 \text{ m s}^{-1}$  at  $\Phi 30 \text{ mm}$  unconfined in air.

### 2.2 Experimental arrangement

The experimental set-up was placed into water contained by an aquarium made of polymethyl methacrylate (PMMA) for the considerations of preventing the projection of the fragments, the disturbance of the filming by explosion gases and of damping the explosion noise. Same photographic observation system was applied to the following two approaches.

#### 2.2.1 Observation of shock wave in case material and in material filled into case

Figure 1 shows the experimental set-up for this test series. Polymethyl methacrylate (PMMA), copper and aluminum were chosen as a case material. And water and sample emulsion explosive named EMX 1 were respectively used as sample material filled in case.

The experimental set-up Type A, B and C in Fig. 1 were adopted for the combination of the PMMA as a case material and water or EMX 1 as a material confined in case. The quadrangles by dashed line in each type illustrate the focusing area to photograph the situation of shock wave propagation.

The experimental set-up Type D in Fig. 1 was adopted for the combination of the copper or aluminum as a case material and water or EMX 1 as a material confined in case. The focusing area to photograph the situation was changed according to its purpose.

Explosive lens was used as a plane shock wave generator to incident the plane shock wave to case material and material filled in case. Explosive lens consists of two kinds of high explosives, SEP (detonation velocity;  $7000 \text{ m s}^{-1}$ ) and HABW (detonation velocity;  $5000 \text{ m s}^{-1}$ ). Explosive lens was initiated by No. 6 electric detonator.

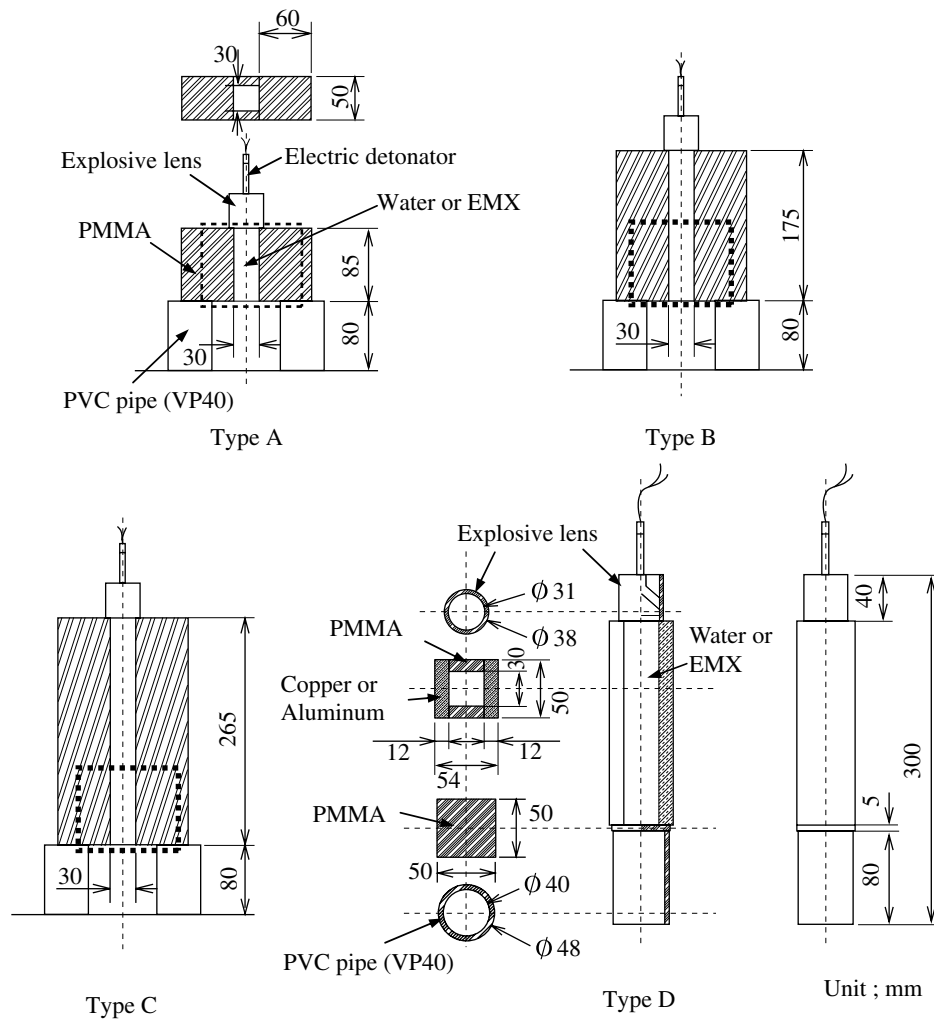

Fig. 1 Experimental set-up for the observation of shock wave in materials.

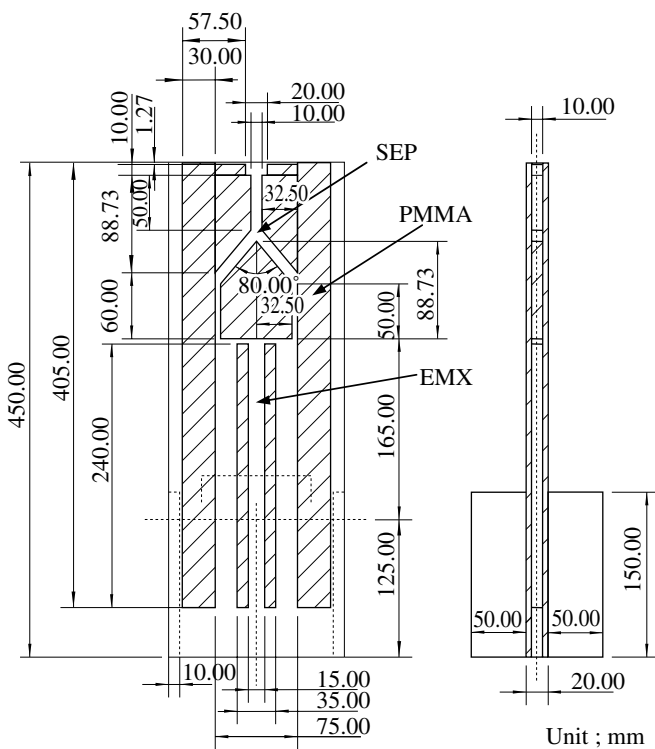

Fig. 2 Experimental set-up for the observation of detonation propagation.

### 2.2.2 Observation of the detonation propagation in emulsion explosives precompressed by shock waves

Figure 2 shows the experimental set-up for this test series. The space framed by PMMA plate at upper area of set-up was filled by high explosive SEP, and the spaces separated into three parts at lower area of set-up were crammed by the combination of SEP and EMX 2 or 3. To vary the pre-compressing condition by shock wave propagating from the

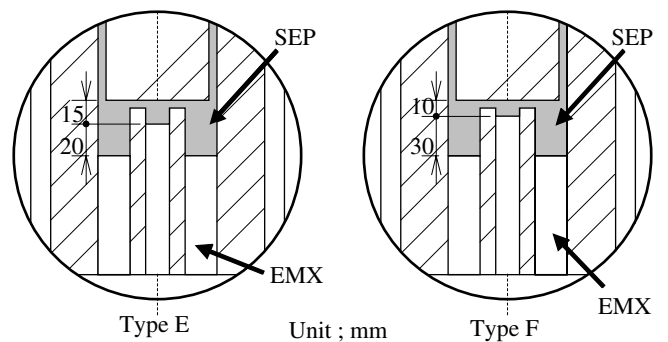

Fig. 3 Enlarged view of lower area of experimental set-up.

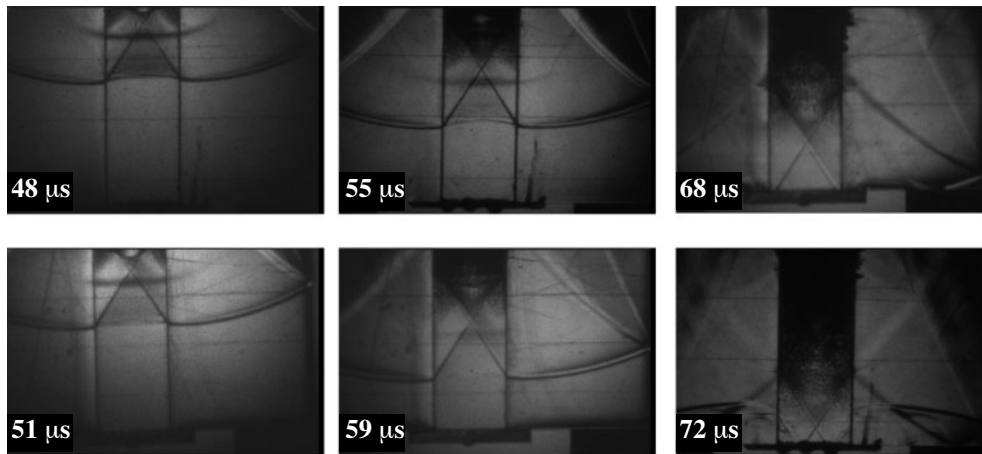

Fig. 4 Photographs of shock wave propagation (case : PMMA, filled material : water) (set-up : Type B).

spaces of both sides to the middle space, the ratio of volume between SEP and EMX was adjusted. Figure 3 shows the enlarged view of lower area of set-up. The top of SEP at the upper area was initiated by No. 6 electric detonator.

### 2.2.3 Photographic observation system

Framing photographs and streak photograph are simultaneously taken by a high-speed camera (IMACOM 468, HADLAND PHOTONICS) using the conventional method of shadowgraph system.

For framing photographic observation, the framing speed was set to be the range from  $10^5$  -  $5 \times 10^5$  fps. Three framing photographs can be available by one test. Therefore, the photo time was stepwise adjusted to compose the continuous framing photographs on several times of tests.

For taking the streak photographs, the sweep time for slit was set to be the range from 12 - 40  $\mu$ s. The optical slit was put on the vertical direction at the center of case material, or at the center of material filled into case. The auxiliary equipment include an Xenon flash light (flashing time : 300  $\mu$ s) and a delay generator. The start of the photography was controlled by ionization wire trigger inserting into the bottom of explosive lens or winding on detonator shell.

## 3. Results and Discussion

### 3.1 Observation of shock wave in case material and in material filled into case

Figures 4 shows the photographs of shock wave propagation by each experiment using the set-up of Type B. PMMA was chosen as a case material, and water was filled in case. A great number of air bubbles can be seen in water area on photographs of photo time after 59  $\mu$ s in Fig. 4. Air bubbles are distributed on the area where the two oblique shock waves from PMMA wall are intersecting. However, air bubbles could not be seen on the experiments using copper or aluminum as a case material. The reason of this phenomenon is deduced from impedance matching method<sup>9)</sup>. When a acoustic wave penetrates from medium 1 to medium 2, its penetration ratio ( $\tau$ ) is represented by the following equation.

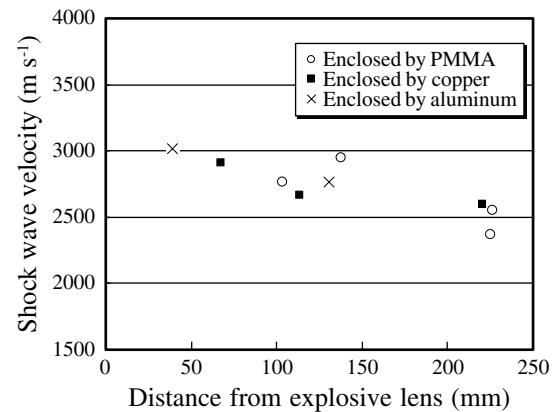

Fig. 5 Shock wave velocities in water enclosed by each material.

$$\tau = \frac{2Z_2}{Z_2 + Z_1}$$

where  $Z_1$  and  $Z_2$  are acoustic impedance densities on medium 1 and medium 2 respectively. Acoustic impedance density ( $Z$ ) is derived from the product of density ( $\rho$ ) and sound velocity ( $c$ ). That is, next equation is given.

$$Z = \rho c$$

Now, the penetration ratio ( $\tau_{\text{PMMA}}$ ) from PMMA to water will be calculated

$$\tau_{\text{PMMA}} = 0.653$$

Regarding other materials, the penetration ratios ( $\tau_{\text{copper}}$ ,  $\tau_{\text{aluminum}}$ ) will be calculated.

$$\tau_{\text{copper}} = 0.082, \quad \tau_{\text{aluminum}} = 0.183$$

Calculation results indicate that it is the most easily to penetrate to water from PMMA compared with from copper or from aluminum. This conclusion will be considered to be

one of the reasons why air bubbles can be only seen on the experiment using PMMA as a case material.

Shock wave velocity or detonation velocity can be derived from the slope of line on streak photograph. Figure 5 demonstrates the shock wave velocities in water enclosed by each material. Independent of the case material, shock wave velocities in water are similar. They are found to decrease and converge for the threshold value. That threshold value is expected to be sound velocity of water ;  $1500 \text{ m s}^{-1}$ .

The detonation velocity of sample emulsion explosive named EMX 1 under the unconfined condition is relatively low. Therefore, EMX 1 is expected to be influenced on the detonation characteristics depending on confining materials. Figure 6 shows the detonation velocities of EMX 1 under the condition of different case materials. It is clear that detonation velocities depend on its case materials. Focusing the above-mentioned acoustic impedance density, we analyze the relationship between acoustic impedance density and detonation velocity. Average values of detonation velocity on each case material in Fig. 6 were

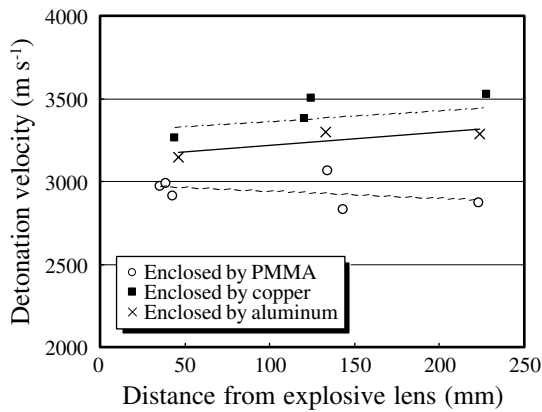

Fig. 6 Detonation velocities of EMX 1 under the several conditions.

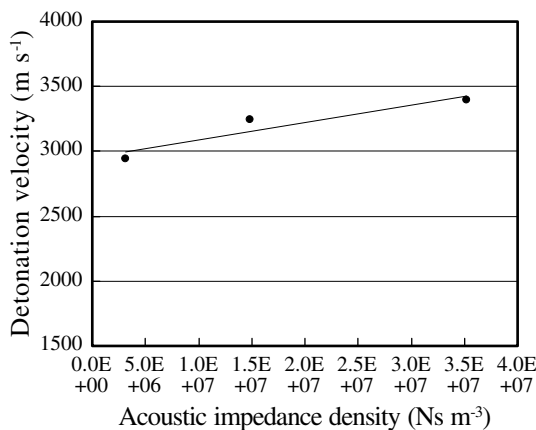

Fig. 7 Relationship between acoustic impedance density and detonation velocity.

used for analysis. Figure 7 shows the result of the plotting each value. Good relationship between acoustic impedance density and detonation velocity is found.

On the occasion of evaluating invisible shock wave propagation inside copper or aluminum, shock wave velocities were estimated by the time interval and the run distance of oblique underwater shock wave on the two continuous framing photographs. Figure 8 summarizes shock wave velocities of inside each material enclosing water or EMX 1. Independent of filled material, which is water or emulsion explosive, each shock wave velocity is found to decrease and converge for sound velocity respectively.

### 3.2 Observation of the detonation propagation in emulsion explosives precompressed by shock waves

Figure 9 shows the photographs of detonation wave propagation taken by two times of experiments. These experiments were conducted by using experimental set-up Type E and sample emulsion explosive named EMX 2. Figure 10 shows the photographs of detonation wave propagation taken by two times of experiments. These experiments were conducted by using the same experimental set-up and sample emulsion explosive named EMX 3.

In both Figs., it can be seen that the width of reaction zone of explosive is relatively narrow compared to the actual width of explosive. This reason is considered as mentioned below. On experimental set-up Type E in Fig. 3, the detonation time lag between the sideline of SEP and the middle line of SEP is estimated to be 4 - 5  $\mu\text{s}$  caused by the devious detonation propagation path of SEP. It is considered that the oblique shock wave generated by the precursor shock wave propagating in PMMA precompress the sample emulsion explosive from side face. Therefore, its reaction zone is reduced because of this dead-pressing. Nevertheless, EMX 2 and EMX 3 can sustain the steady detonation propagation. These evidences can make judg-

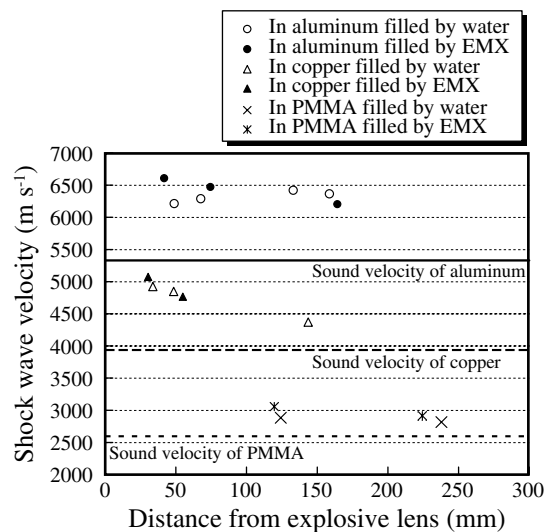

Fig. 8 Shock wave velocities of inside each material enclosing water or EMX 1.

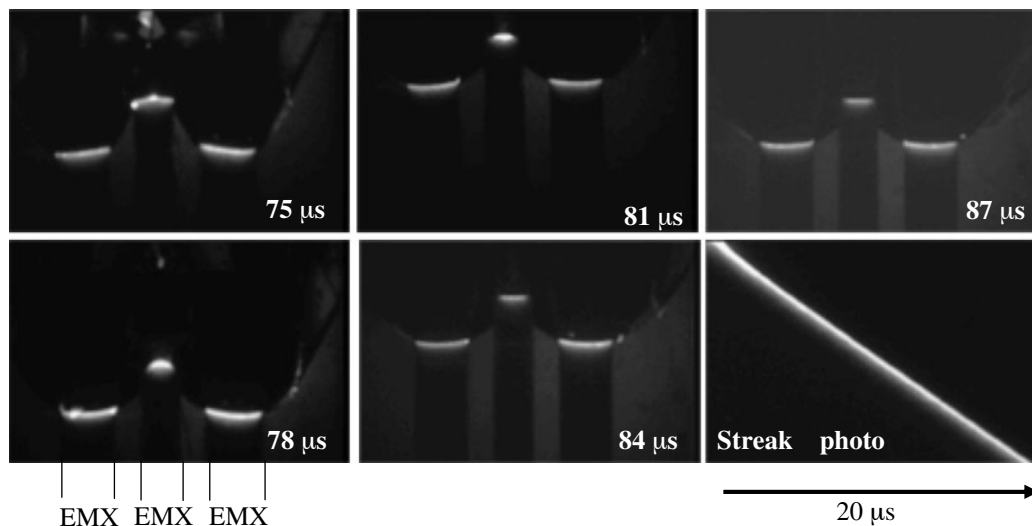

Fig. 9 Photographs of detonation wave propagation using EMX 2 (set-up : Type E).

ment from the slop of each streak photo. The detonation velocities calculated from slops are EMX 2 ;  $4020 \text{ m s}^{-1}$  and EMX 3 ;  $4480 \text{ m s}^{-1}$  respectively. It is deduced that the steady detonation propagation with narrow reaction zone is attributed to confinement effect.

On experimental set-up Type F in Fig. 3, this set-up was designed to get a longer precompression period to the sample emulsion explosive in the middle line. Additional pre-compression period was estimated to be  $1 \mu\text{s}$ . Because the designed period was short, there was no different about experimental results between the both trials using the set-up Type F and Type E. Sample emulsion explosives behaved the stable detonation propagation. Additional experiments that appropriate precompression period is available will be required in the near future.

#### 4. Conclusions

The following conclusions were obtained in this study ;

- A great number of air bubbles can be seen in water area where the two oblique shock waves from PMMA wall are intersecting.
- Independent of the case material, shock wave velocities in water are similar.
- Good relationship between acoustic impedance density of case materials and detonation velocity is found.
- Independent of filled material, each shock wave velocity is found to decrease and converge for sound velocity respectively.
- The reaction zone of sample emulsion explosive is reduced because of the oblique shock wave generated by the precursor shock wave propagating in PMMA. Nevertheless, emulsion explosive can sustain the steady detonation propagation.

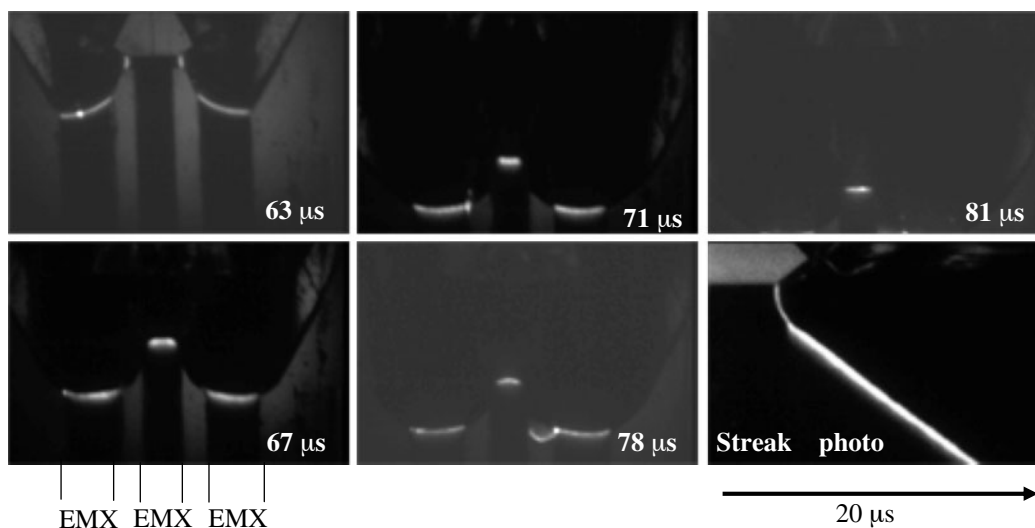

Fig. 10 Photographs of detonation wave propagation using EMX 3 (set-up : Type E).

**Reference**

- 1) M. Yoshida, M. Iida, K. Tanaka, S. Fujiwara, M. Kusakabe, and K. Shiino, Proc. of the Eighth Symposium (International) on DETONATION, pp. 993-1000 (1985), Albuquerque.
- 2) J. Lee, F. W. Sandstrom, B. G. Craig, and P. A. Persson, Proc. of the Ninth Symposium (International) on DETONATION, pp. 573-584 (1989), Portland.
- 3) J. Lee, and P. A. Persson, Propellants, Explosives, Pyrotechnics, Vol. 15, pp. 208-216 (1990).
- 4) M. M. Chaudhri, L. Almgren, and A. Persson, Tenth International DETONATION Symposium, pp. 741-748 (1993), Boston.
- 5) A. C. van der Steen, H. H. Kodde, and A. Miyake, Propellants, Explosives, Pyrotechnics, Vol. 15, pp. 58-61 (1990).
- 6) H. Arai, Y. Ogata, Y. Yuji, A. Miyake, W. Jung, J. Nakamura, and T. Ogawa, Sci. and Tech. Energetic Materials, Vol. 65, pp. 201-205 (2004).
- 7) S. Esen, Rock Mechanics and Rock Engineering, Vol. 37, pp. 317-330 (2004).
- 8) P. C. Souers, P. Vitello, S. Esen, J. Kruttschnitt, and H. A. Bilgin, Propellants, Explosives, Pyrotechnics, Vol. 29, pp. 19-26 (2004).
- 9) K. Tanaka, J. Ind. Explos. Soc. Japan (Kogyo Kayaku), Vol. 37, pp. 277-290 (1976) (in Japanese).

---

---

## 容器内を伝播する衝撃波による、 エマルジョン爆薬の爆轟特性への影響

角谷文彦<sup>\*</sup>，濱嶋英樹<sup>\*\*</sup>，加藤幸夫<sup>\*</sup>，伊東 繁<sup>\*\*</sup>

エマルジョン爆薬のような非理想爆轟特性を示す爆薬は、装填される容器でその爆轟特性が大きく影響を受けることが知られている。容器の物理的特性値が爆轟特性、特に爆速にどのような影響を及ぼすかを光学的観測手法を用いて試験室スケールで検討を行った。

容器の材質として、PMMA、銅、アルミニウムを選定し爆速測定を実施した結果、これら材質の密度と音速の積より求められる音響インピーダンス密度と、爆速との関係が良好な相関関係を示した。

<sup>\*</sup>日本油脂(株) 武豊工場 研究開発部 〒470-2398 愛知県知多郡北小松谷61-1

<sup>†</sup>corresponding author: fumihiko\_sumiya@nof.co.jp

<sup>\*\*</sup>熊本大学 衝撃・極限環境研究センター 〒860-8555 熊本県熊本市黒髪2-39-1